

Repasemos las vocales (A a).

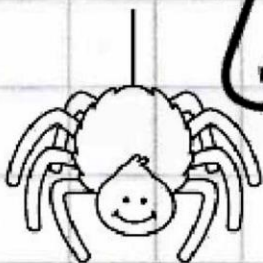

araña

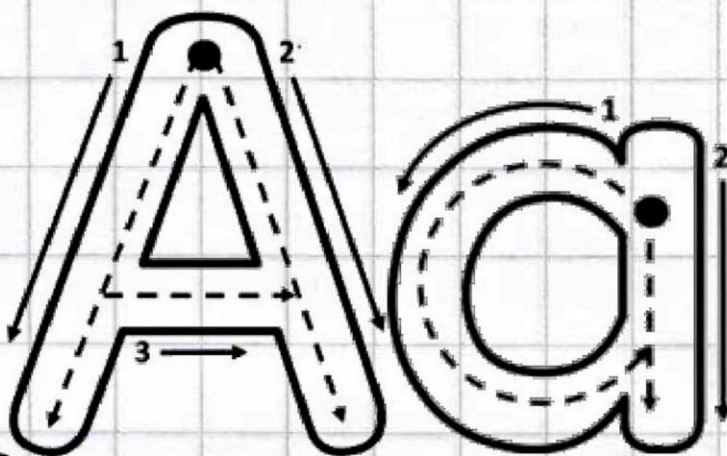
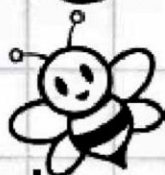

abeja



anillo



Repasemos las vocales (A a).



araña

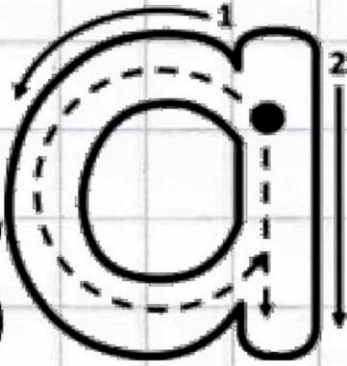
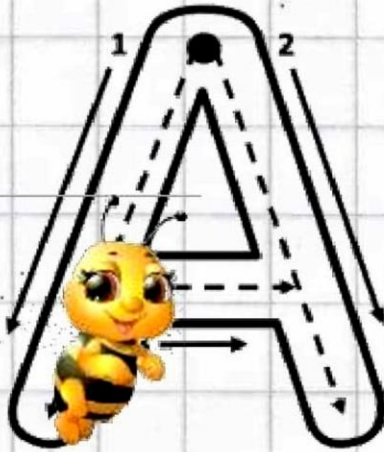

árbol

A a

A a

A a

A a



Aprendamos la vocales (A a),
colorea.

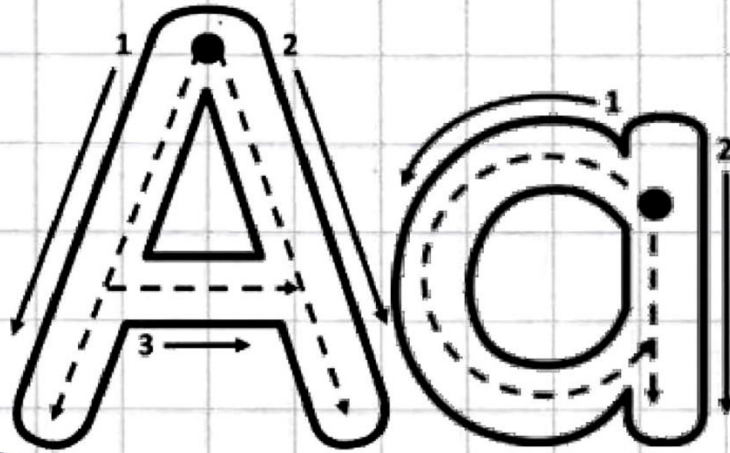

arcoíris

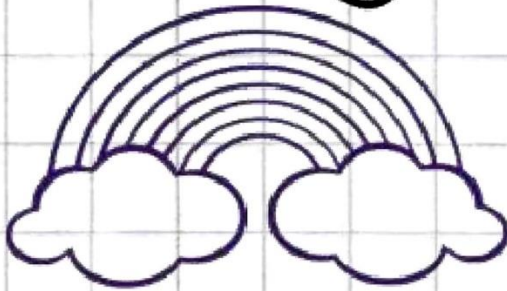

__rcoíris

árbol

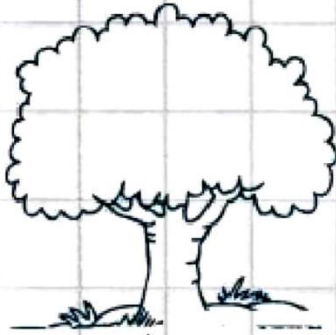

__rbol

araña



__r __ ñ__

abeja



__bej__

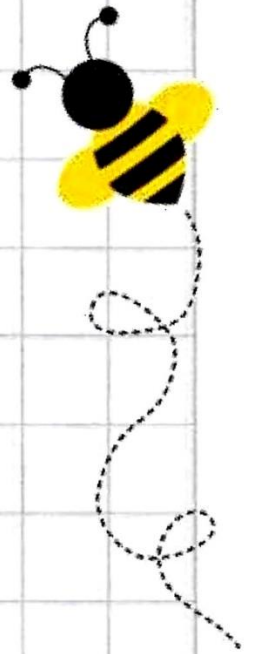

Decora la vocal (A a).

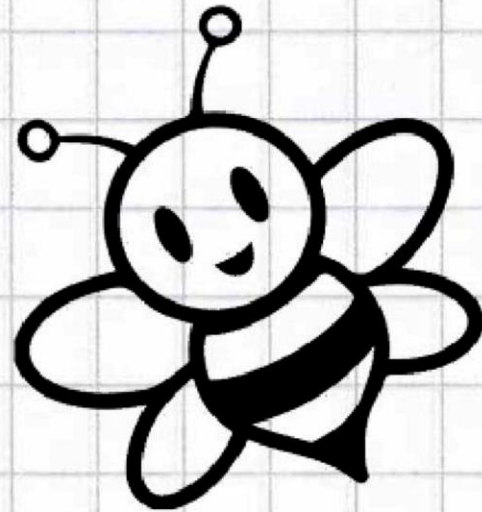
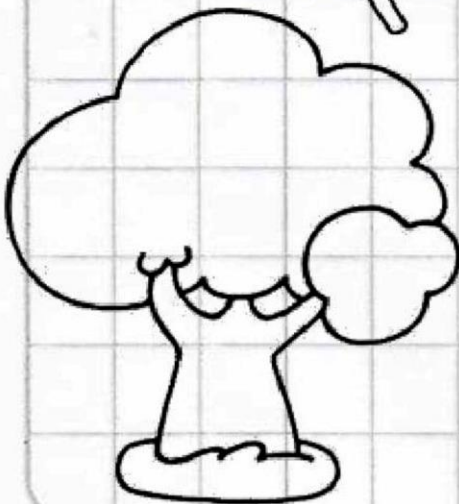
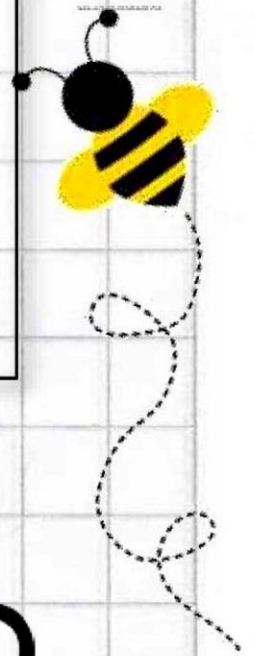
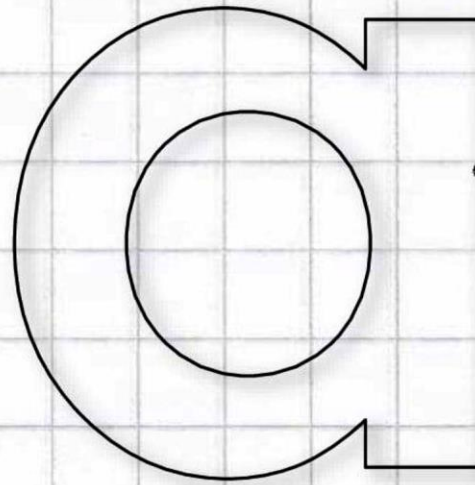
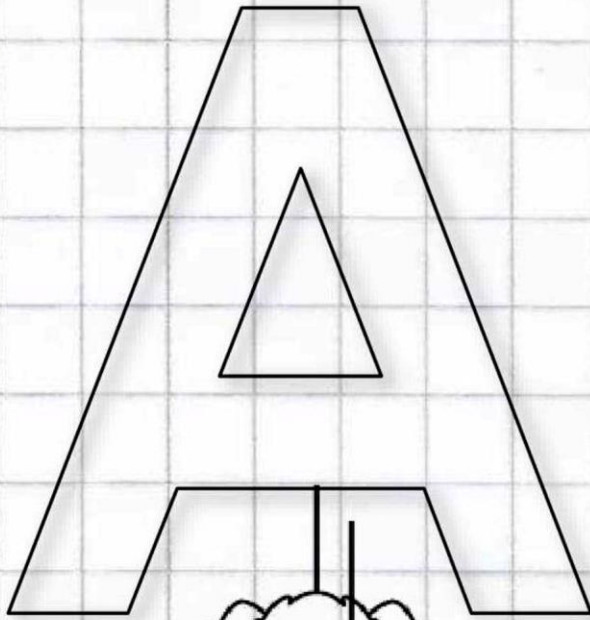
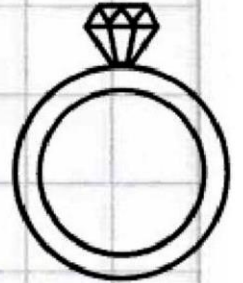
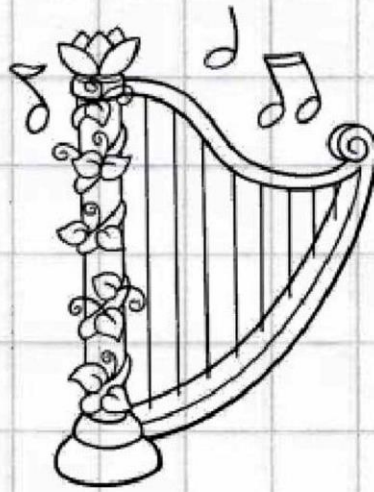
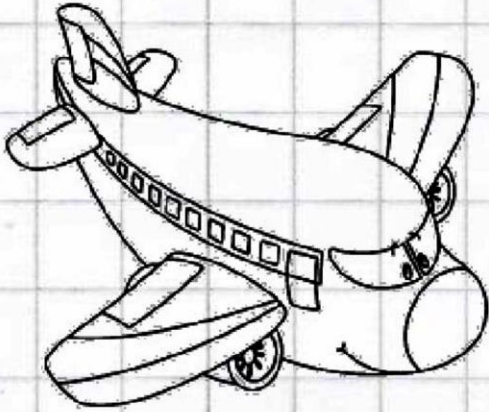

Repasemos las vocales (E e).

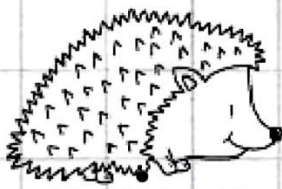
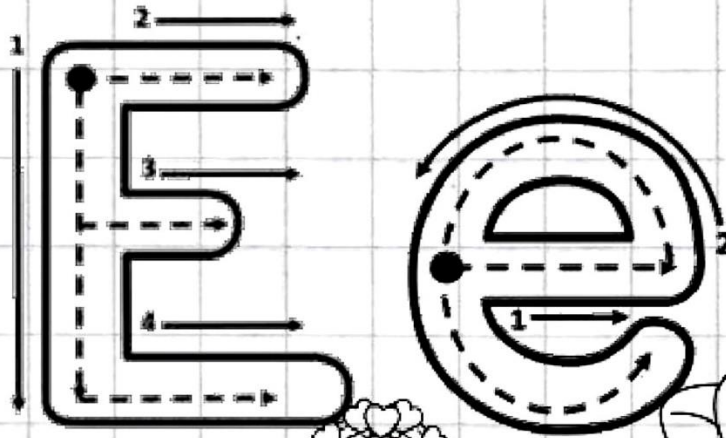

erizo



espejo

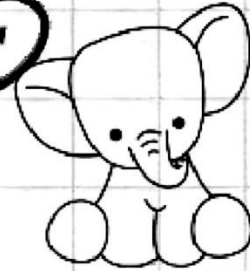

elefante



Repasemos las vocales (E e).



estrella



E

e



E e

Ee

Ee

Ee



Decora la vocal (E e).

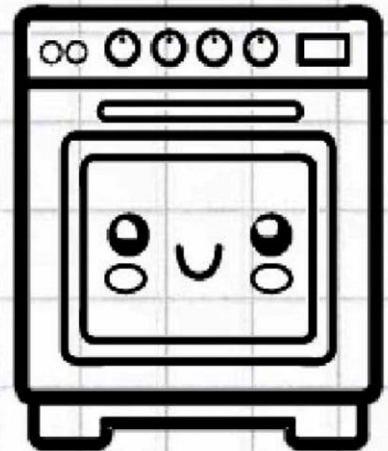
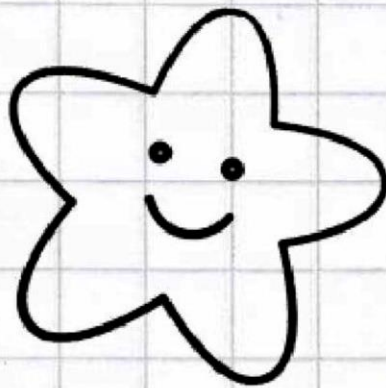
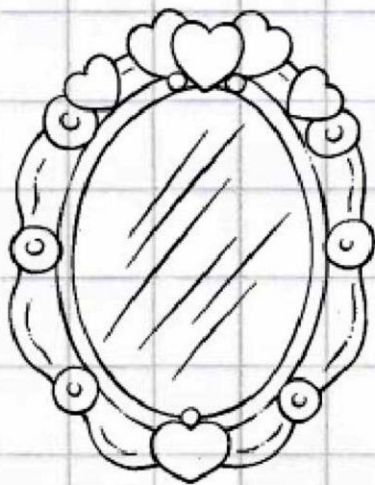
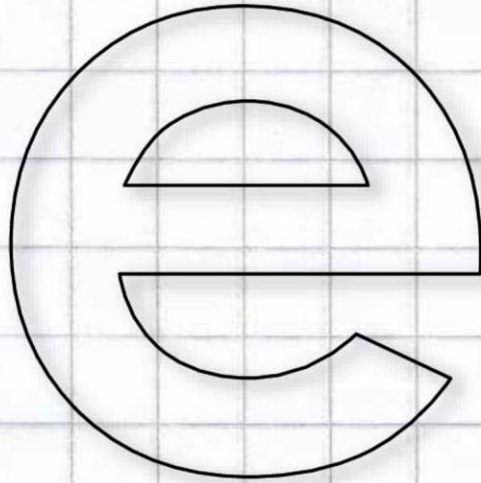
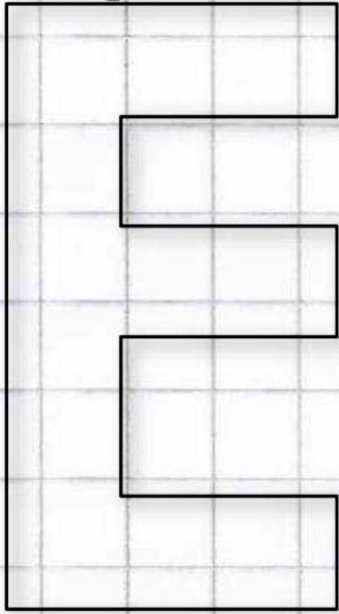
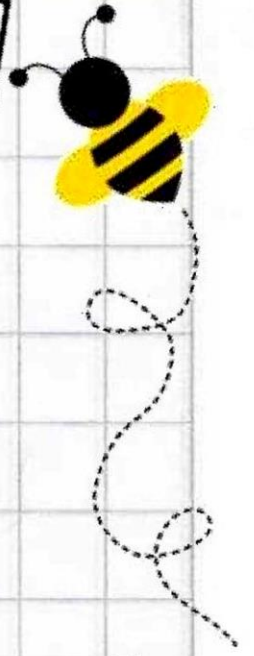
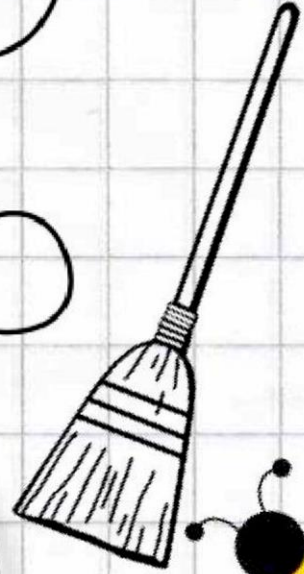
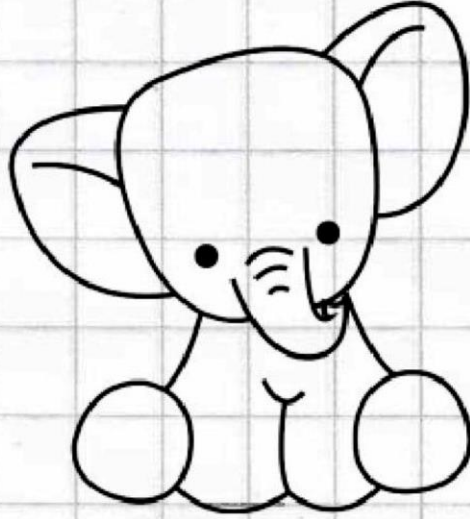
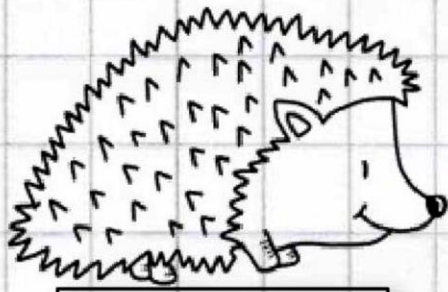

Aprendamos la vocal (E e),



colorea.

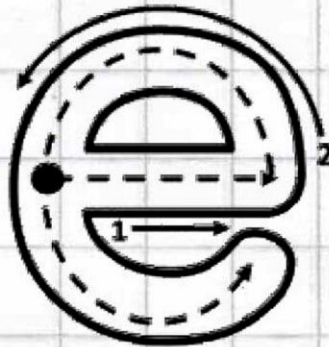
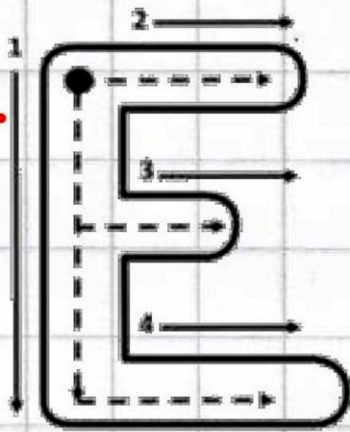

elefante

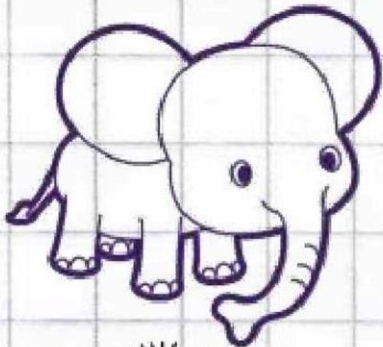

__l__fant__



erizo



__rizo



escoba



__scoba



Estrella

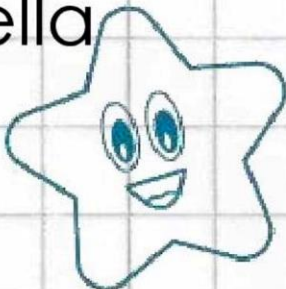

__str__lla

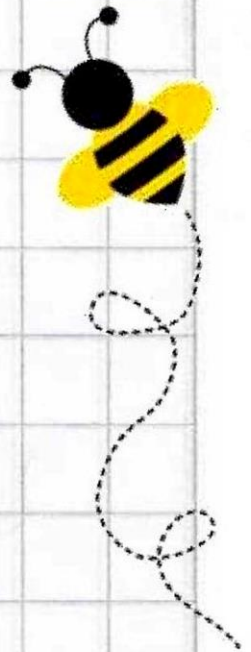
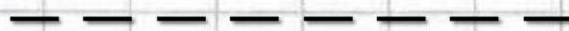

Decora la vocal (l i).

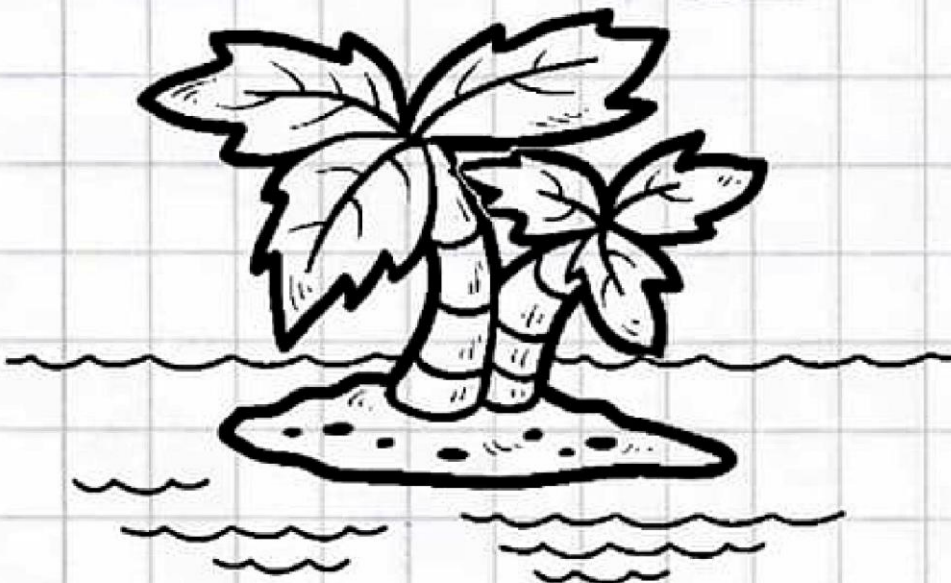
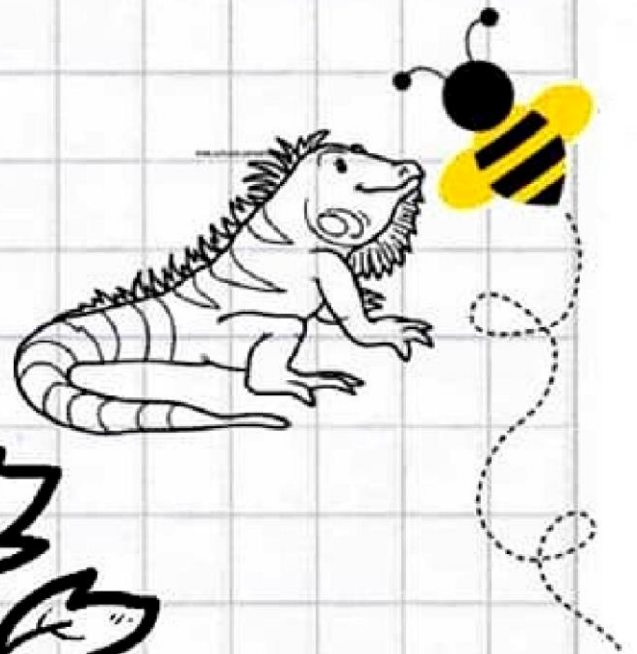
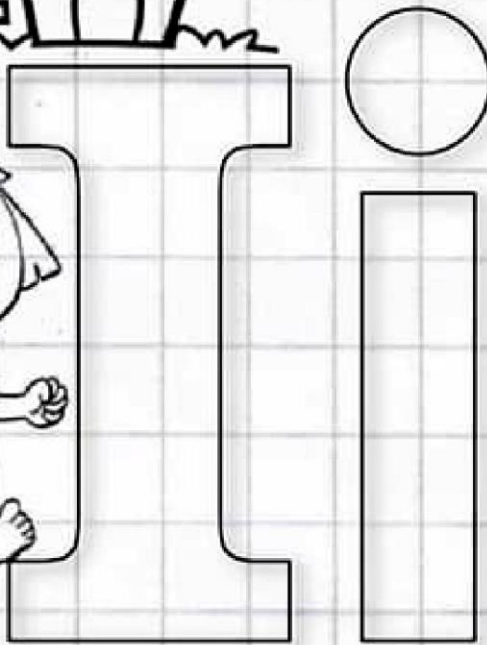
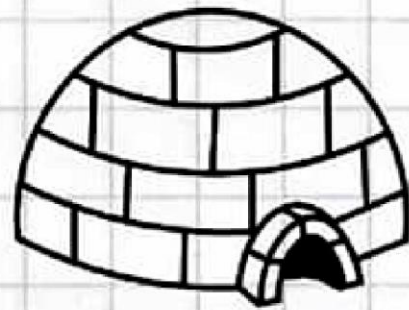

Aprendamos la vocal (I i), colorea.

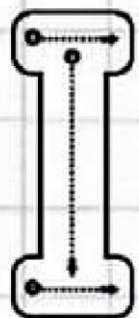

iglesia

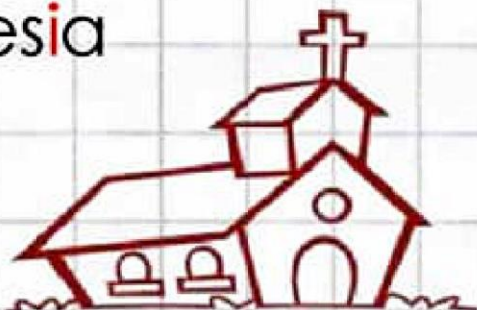

__gles__a



iguana

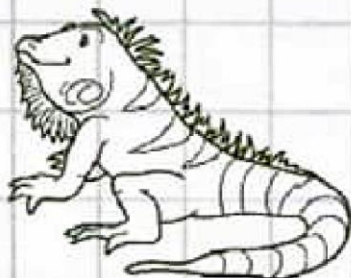

__guana



impresora

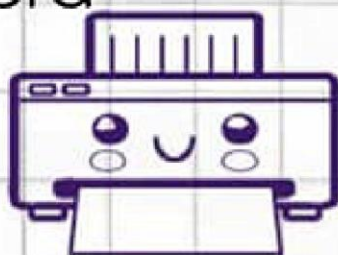

__mpresora



isla

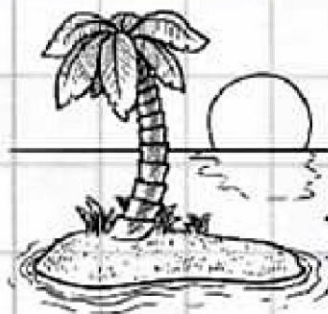

__sla

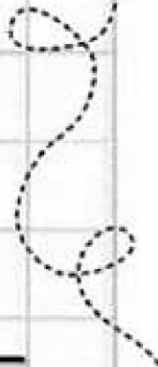

Repasemos la vocal (I i).



iglú



Ii



isla

Ii

Ii

Ii

Ii



Repasemos la vocal (l i).

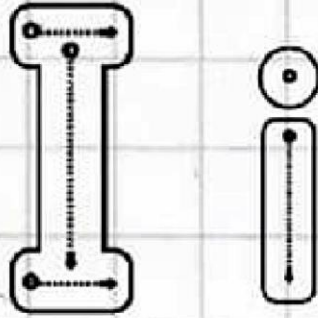

iglesia



indio

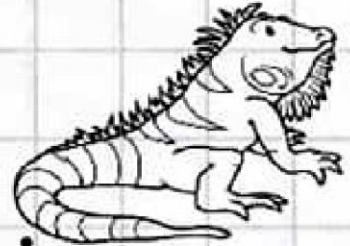

iguana



Decora la vocal (O o).

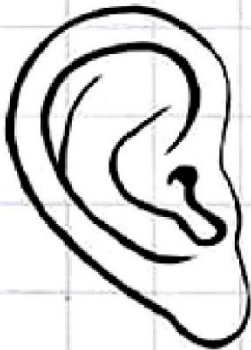
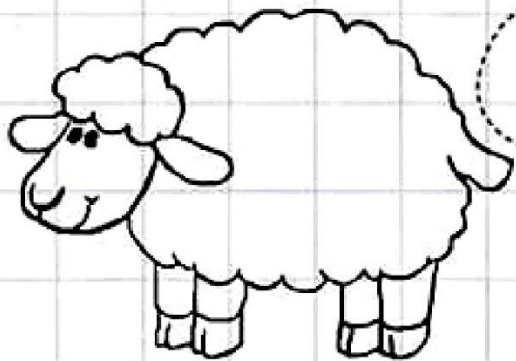
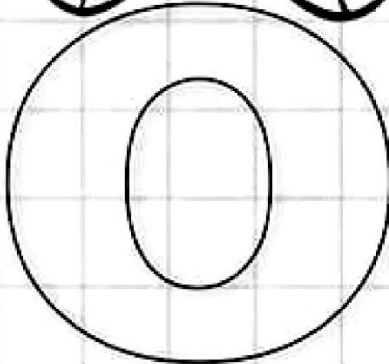
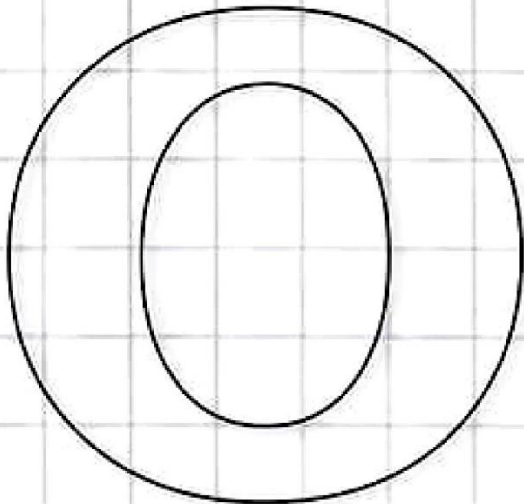
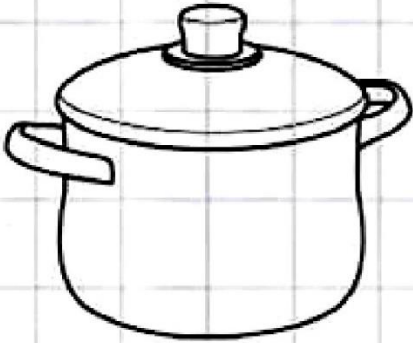

Repasemos la vocal (O o), colorea.

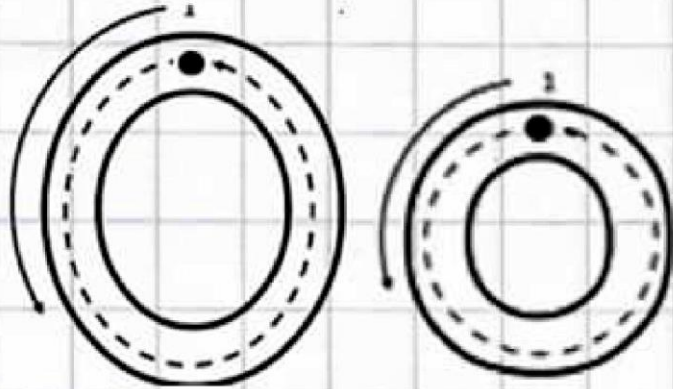

__s__

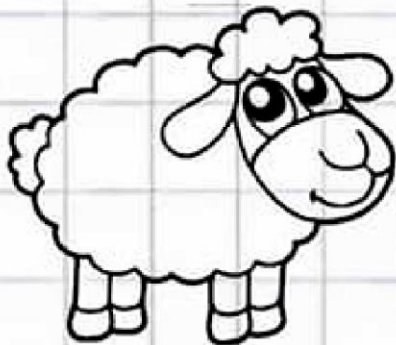

__veja

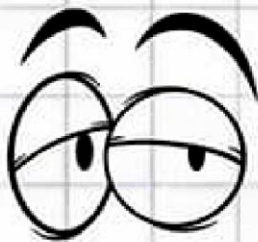

__j__

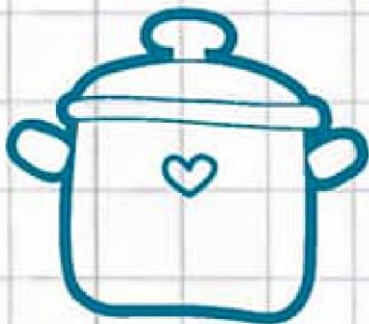

__lla

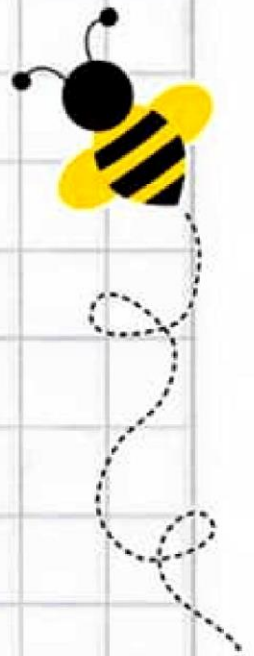

Repasemos la vocal (O o).



olla

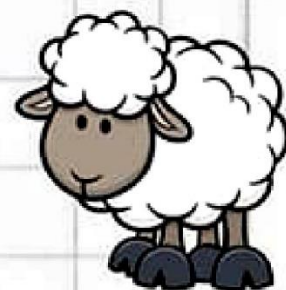

oveja

O o

O o

O o

O o



Repasemos la vocal (O o).

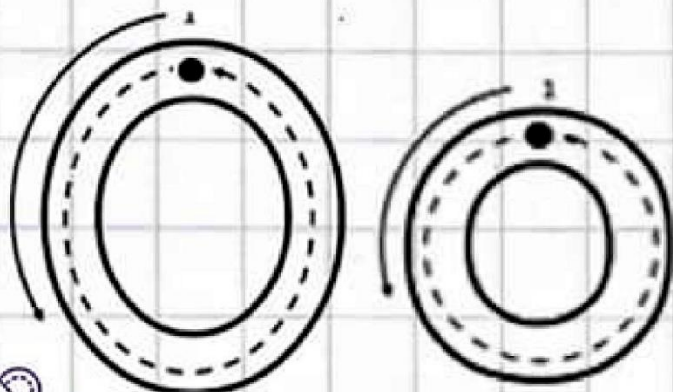

OSO

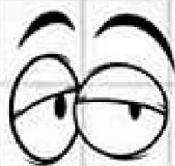

OJOS

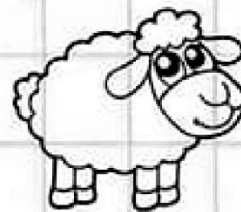

OVEJA



Decora la vocal (U u).

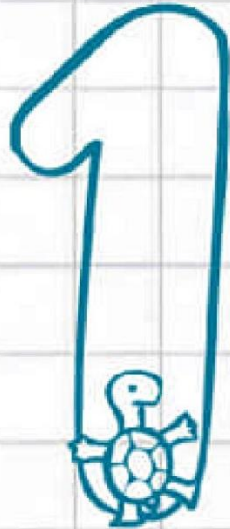
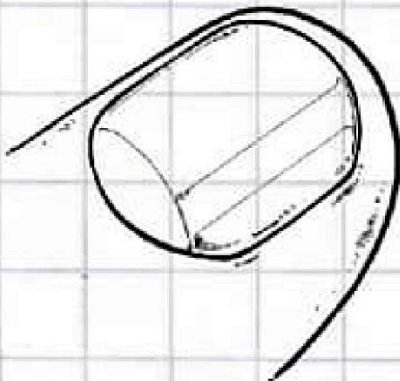
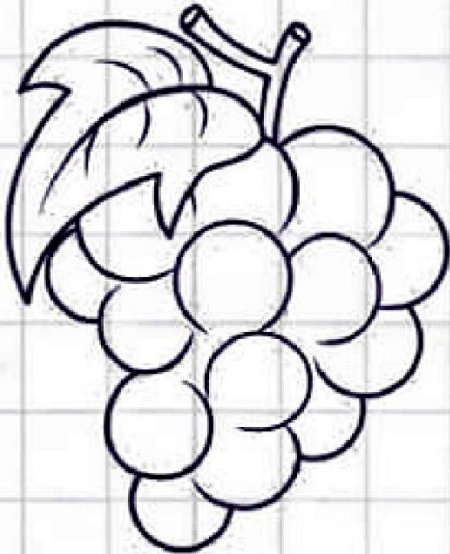
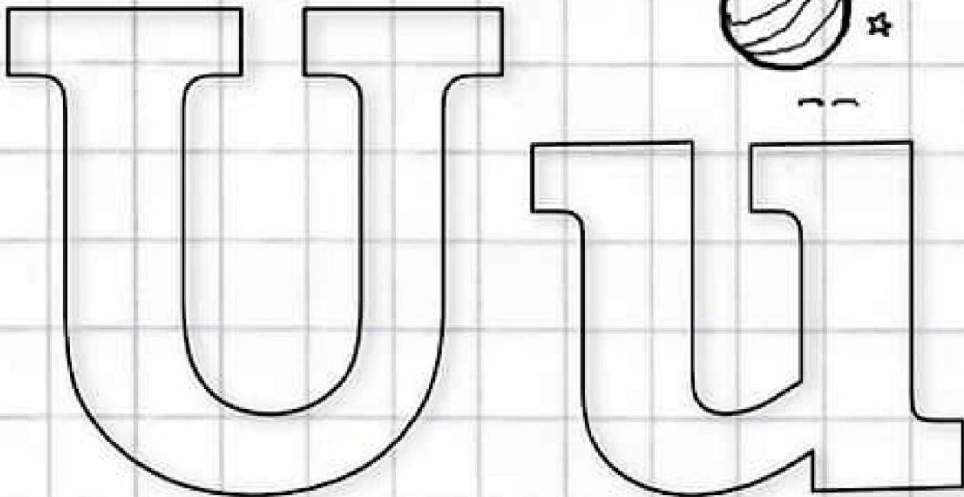
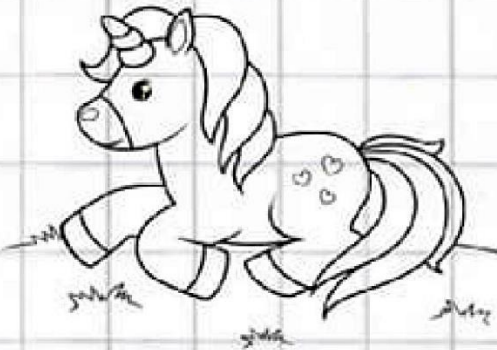

Repasemos la vocal (U u), colorea.

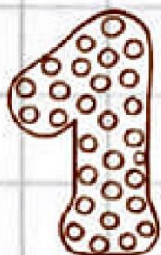
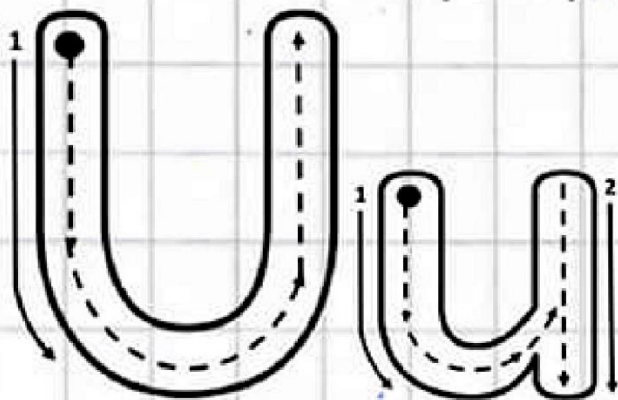

__no

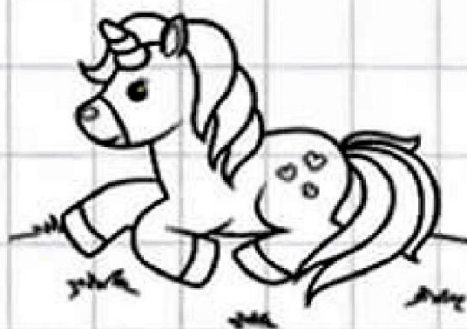

__nicornio

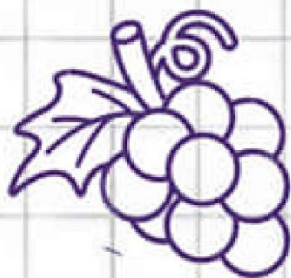

__vas

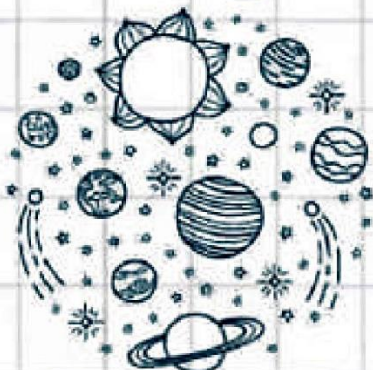

__niverso

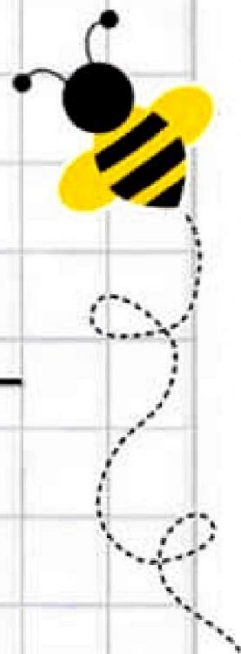

Repasemos la vocal (u u).

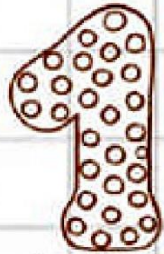
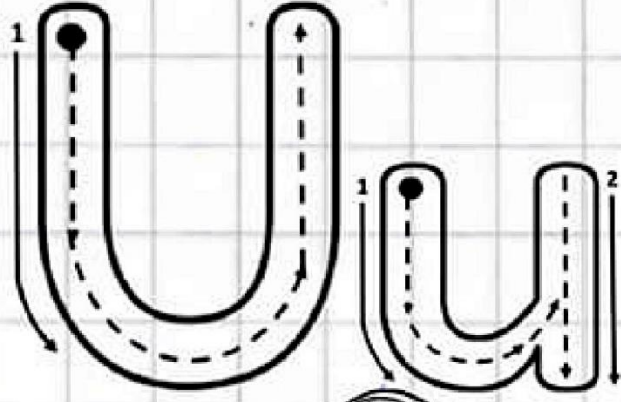

uño

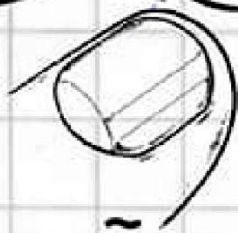

uña

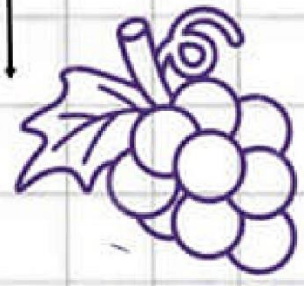

uvas



Repasemos la vocal, (U u).

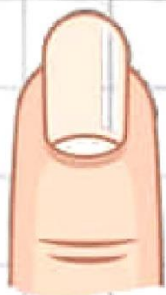

uña

U U

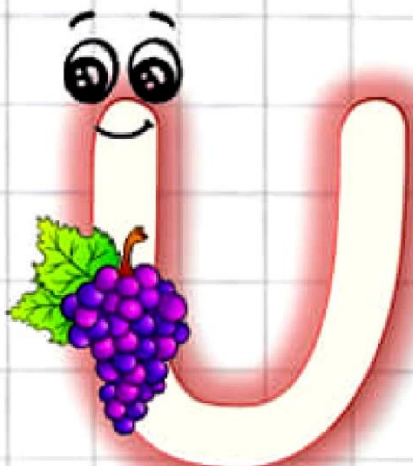

U U



U U



uno

U U

