

CUADERNILLO DE TRAZOS

Sílabas trabadas

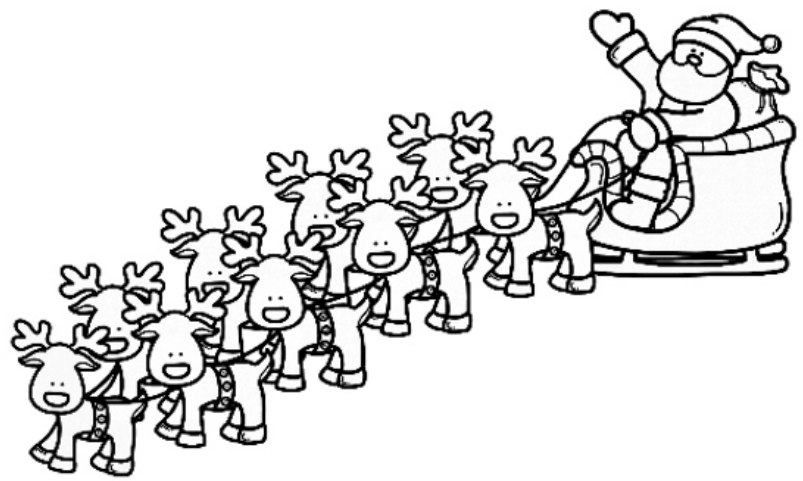

Nombre: _____

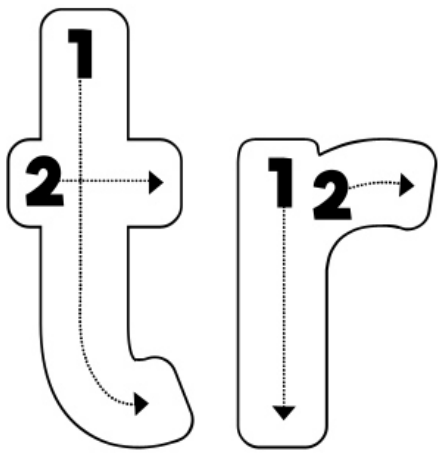

Traza siguiendo las indicaciones 

tra-tre-tri-tro-tru

tra-tre-tri-tro-tru

tra-tre-tri-tro-tru

tra-tre-tri-tro-tru

tra-tre-tri-tro-tru

trueno-tren-trineo

Sílabas perdidas

tr

Escribe la sílaba que falta y colorea los dibujos.

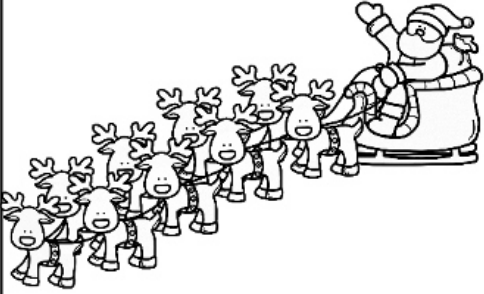

___ neo



___ ce

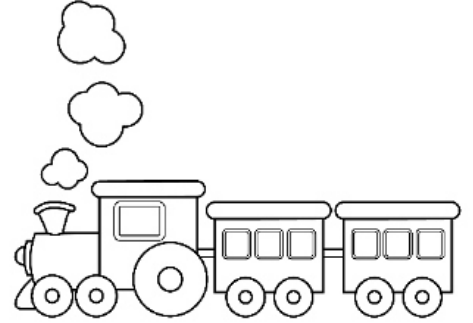

___ n



___ mpeta



___ ste

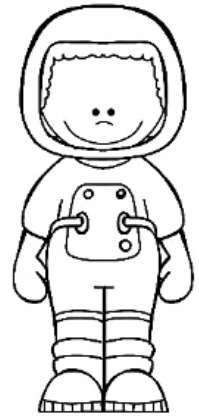

as ___ nauta



maes ___

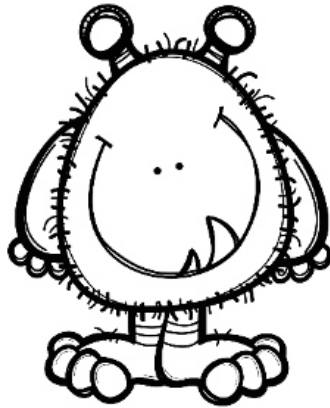

mons ___ o



es ___ lla

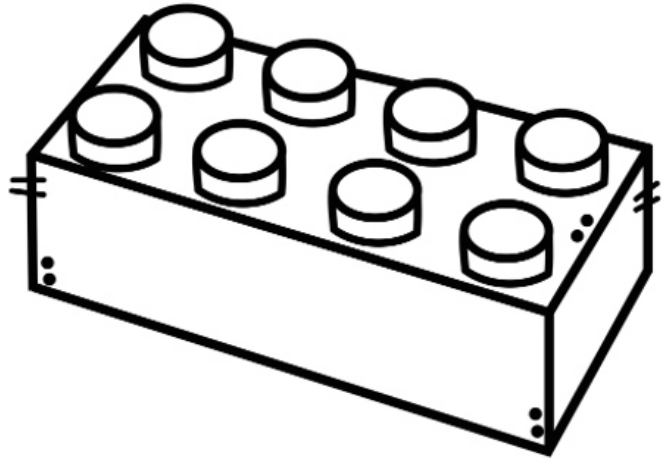
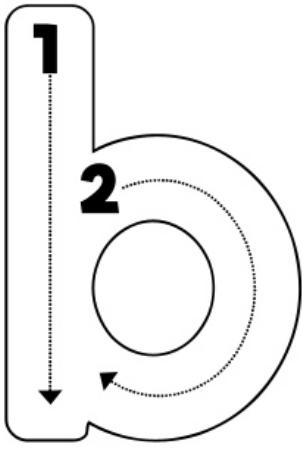

Traza siguiendo las indicaciones 

b a - b e - b i - b o - b u -

b a - b e - b i - b o - b u -

b a - b e - b i - b o - b u -

b a - b e - b i - b o - b u -

b a - b e - b i - b o - b u -

blusa - cable - hablar

Sílabas perdidas

bl

Escribe la sílaba que falta y colorea los dibujos.



esta ____

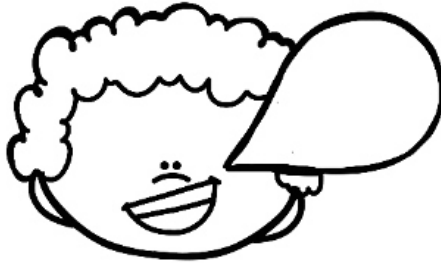

ha ____ r



____ sa

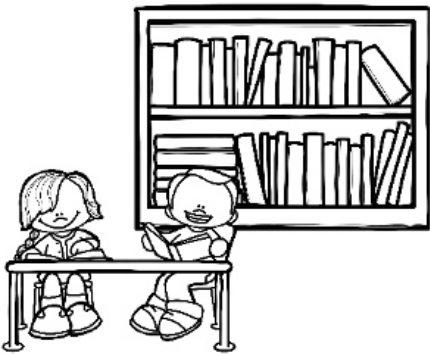

bi ____ oteca

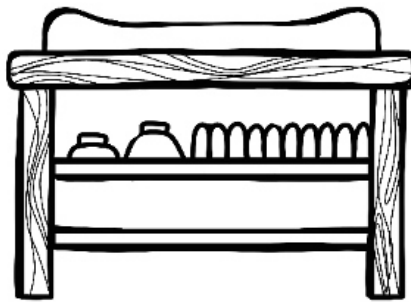

mue ____

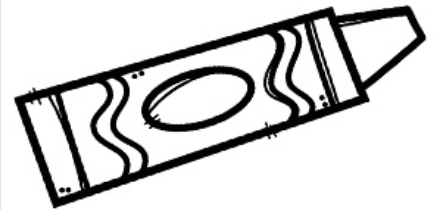

____ nco

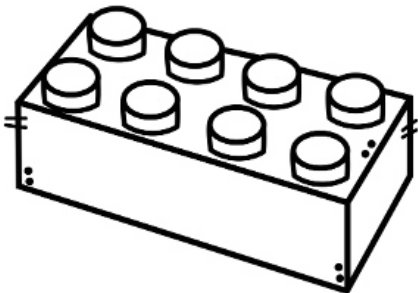

____ que

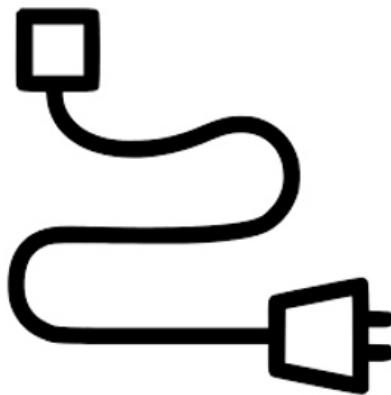

ca ____

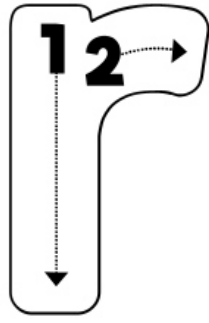
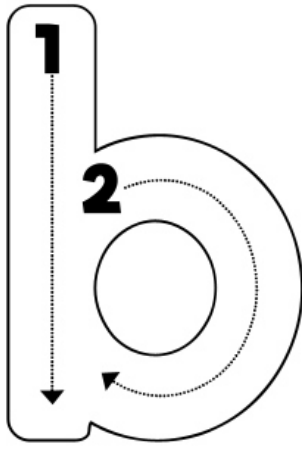

Traza siguiendo las indicaciones 

bra-bre-bri-bro-bru

bra-bre-bri-bro-bru

bra-bre-bri-bro-bru

bra-bre-bri-bro-bru

bra-bre-bri-bro-bru

brazo-broche-broma

Sílabas perdidas

br

Escribe la sílaba que falta y colorea los dibujos.

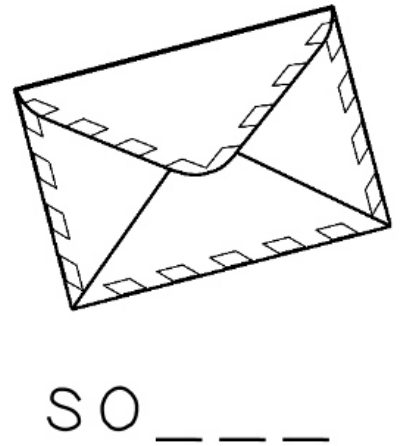
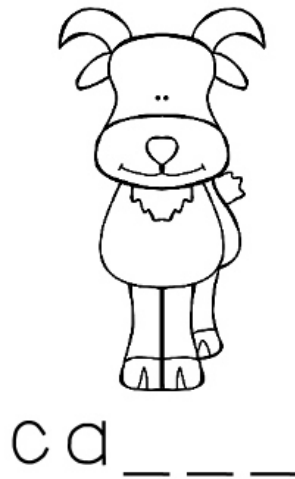
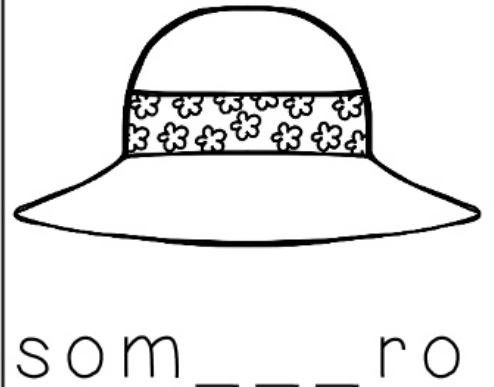
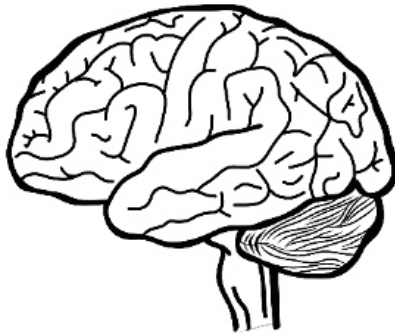
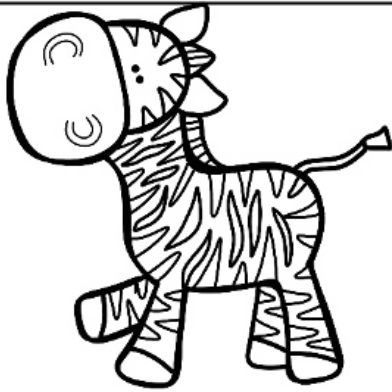

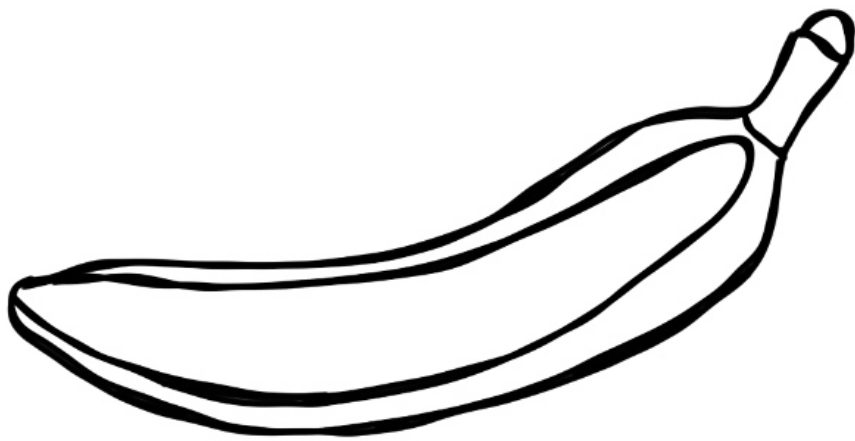
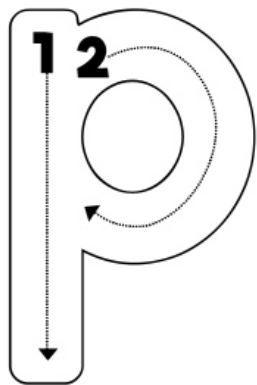

Traza siguiendo las indicaciones 

p | a - p | e - p | i - p | o - p | u -

p | a - p | e - p | i - p | o - p | u -

p | a - p | e - p | i - p | o - p | u -

p | a - p | e - p | i - p | o - p | u -

p | a - p | e - p | i - p | o - p | u -

p | l | a | z | a - p | l | u | m | a - p | l | o | m | e | r | o



Sílabas perdidas

pl

Escribe la sílaba que falta y colorea los dibujos.

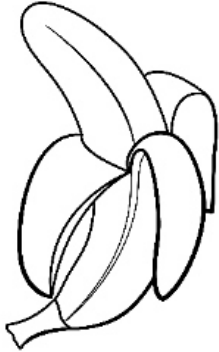

___ tano

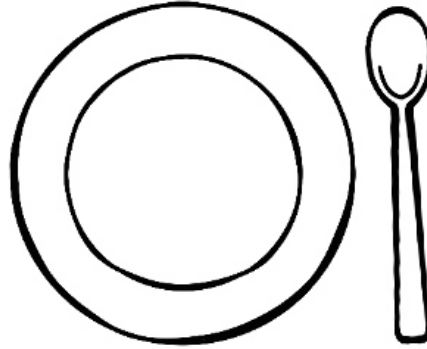

___ to



___ ya



___ mero

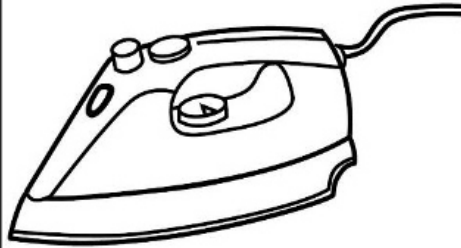

___ ncha



cum ___ años



di ___ ma



___ ma



___ nta

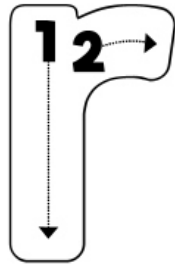
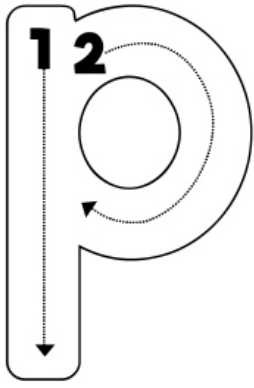

Traza siguiendo las indicaciones 

pra-pre-pri-pro-pru

pra-pre-pri-pro-pru

pra-pre-pri-pro-pru

pra-pre-pri-pro-pru

pra-pre-pri-pro-pru

compra-presos-pronto-

Sílabas perdidas

pr

Escribe la sílaba que falta y colorea los dibujos.



___ cipe

1º

___ mero

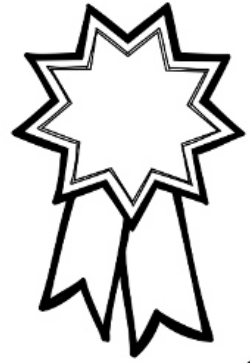

___ mio

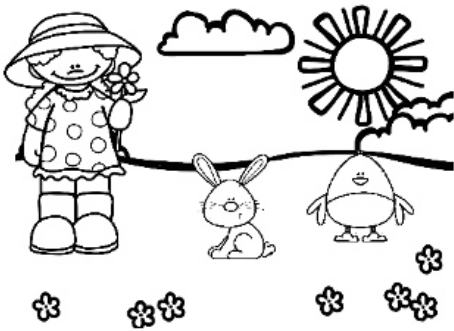

___ mavera



___ ncesa

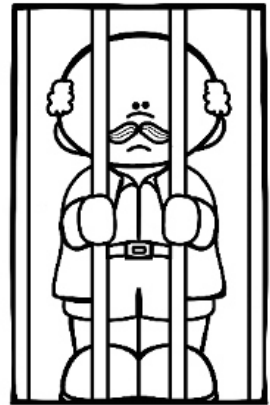

___ so



___ cio



___ fesor

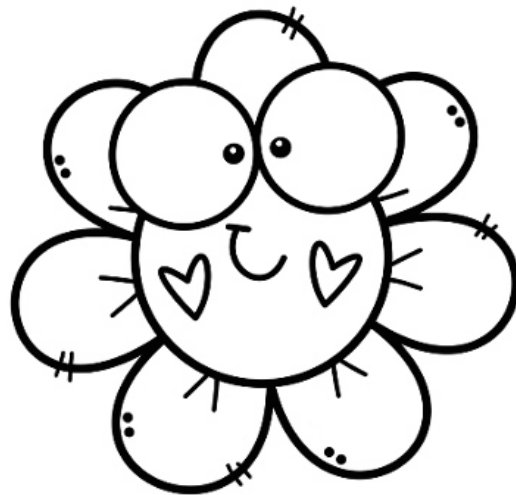
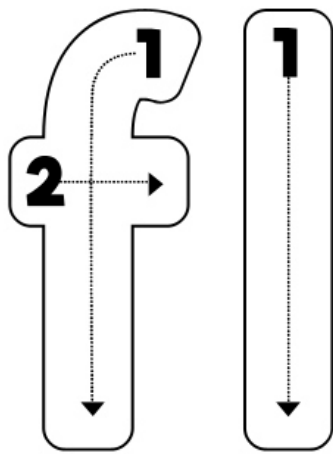

Traza siguiendo las indicaciones 

f-la-f-le-f-li-f-lo-f-lu-

f-la-f-le-f-li-f-lo-f-lu-

f-la-f-le-f-li-f-lo-f-lu-

f-la-f-le-f-li-f-lo-f-lu-

f-la-f-le-f-li-f-lo-f-lu-

flan-flotar-flaco-flor

Sílabas perdidas

fl

Escribe la sílaba que falta y colorea los dibujos.

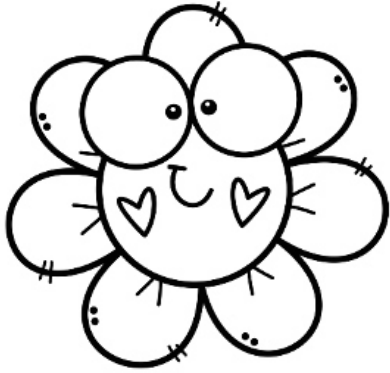

___ r



___ co

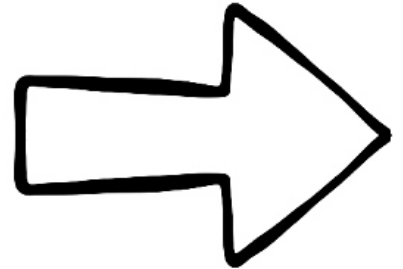

___ cha



___ mingo



___ jo



___ ma



___ rero

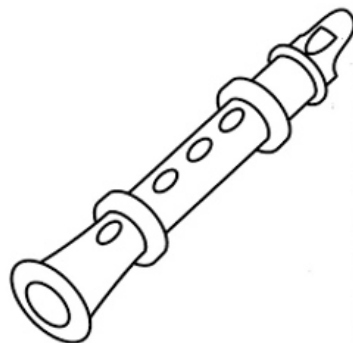

___ uta



___ co

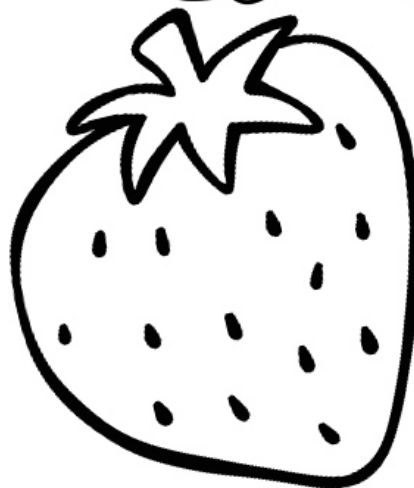
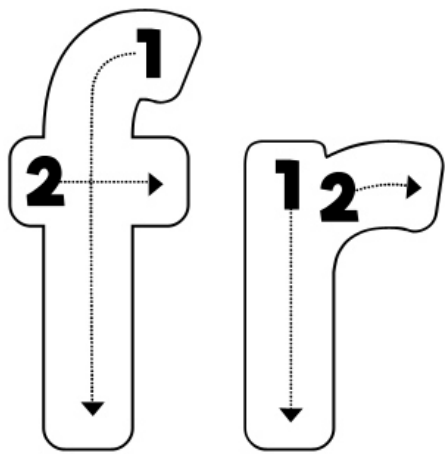

Traza siguiendo las indicaciones 

fra-fre-fri-fro-fru

fra-fre-fri-fro-fru

fra-fre-fri-fro-fru

fra-fre-fri-fro-fru

fra-fre-fri-fro-fru

freno-frotar-fresa-

Sílabas perdidas

fr

Escribe la sílaba que falta y colorea los dibujos.

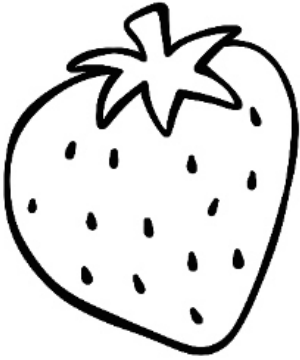

___ sa

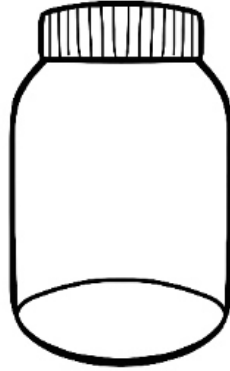

___ sco

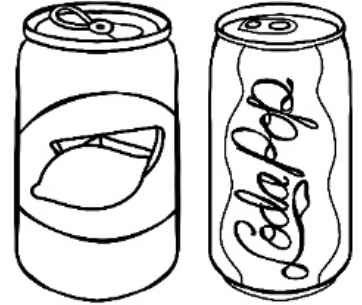

re ___ sco



co ___



dis ___ z

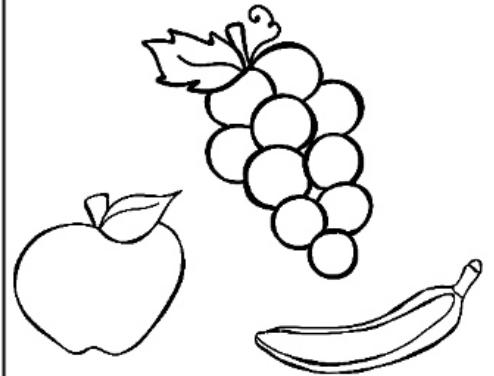

___ tas

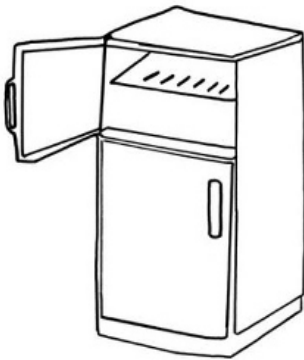

Re ___ gerador



Á ___ ca

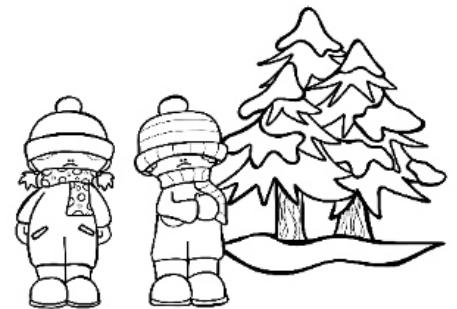

___ o

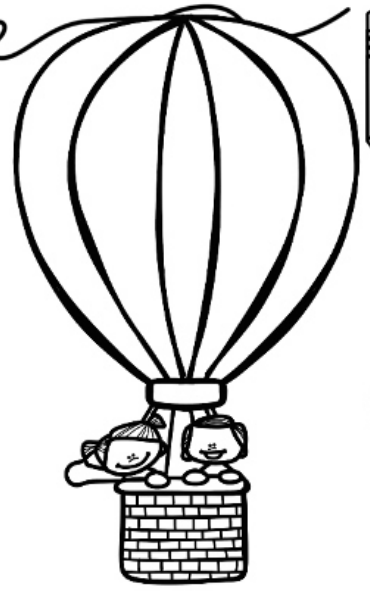
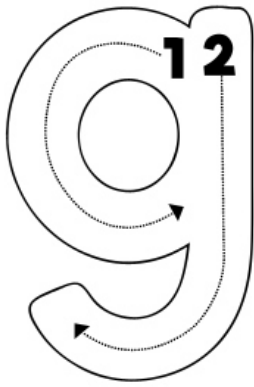

Traza siguiendo las indicaciones 

gla-gle-gli-glo-glu-

gla-gle-gli-glo-glu-

gla-gle-gli-glo-glu-

gla-gle-gli-glo-glu-

gla-gle-gli-glo-glu-

globo-omboligo-regla

Sílabas perdidas

91

Escribe la sílaba que falta y colorea los dibujos.

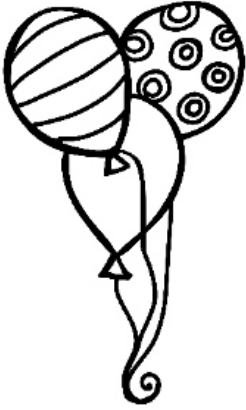

___ bos



i ___ sia

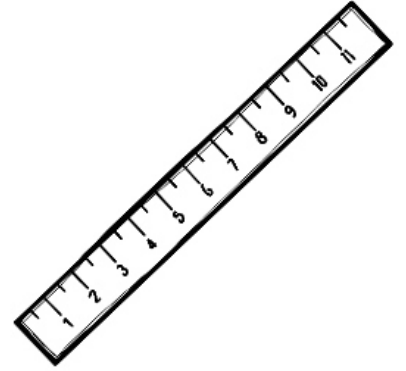

re ___

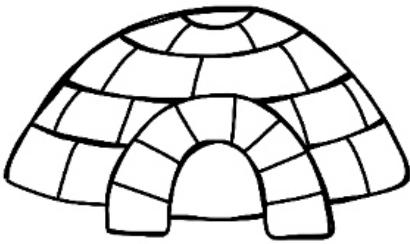

i ___



in ___ s

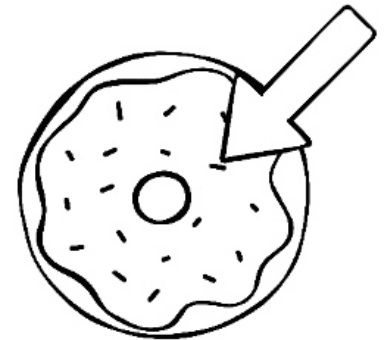

___ seado

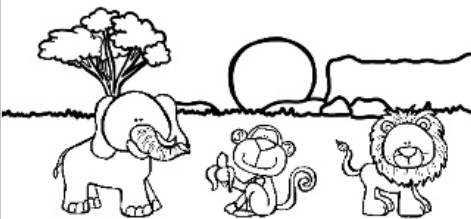

jun ___



___ ria

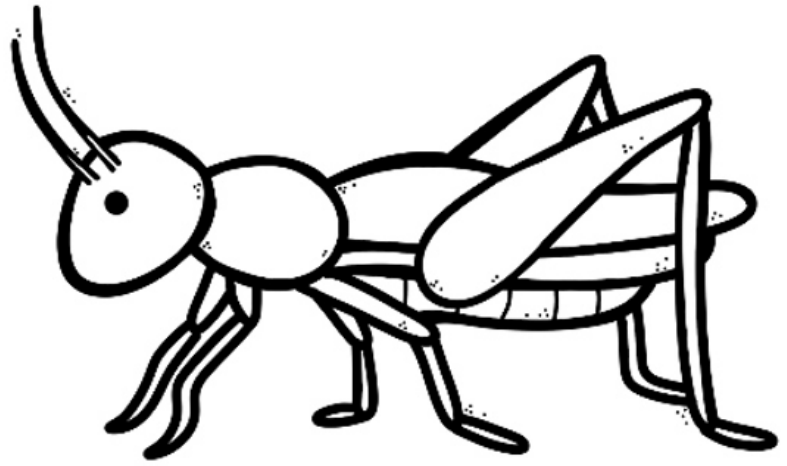
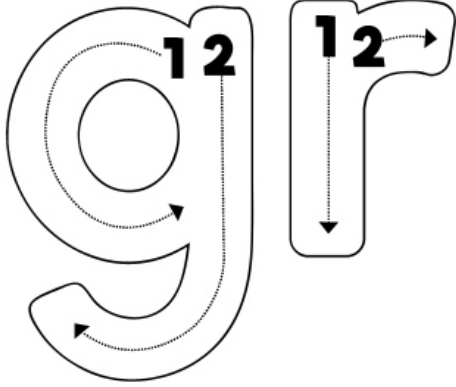

Traza siguiendo las indicaciones 

gra-gra-gra-gra-gra-gra

gre-gre-gre-gre-gre-gre

gri-gri-gri-gri-gri-gri

gro-gro-gro-gro-gro-gro

gru-gru-gru-gru-gru-gru

gracias-gracias-gracias-gracias-gracias-gracias

Sílabas perdidas

gr

Escribe la sílaba que falta y colorea los dibujos.

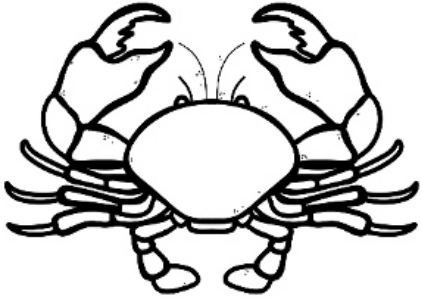

can ___ _ jo

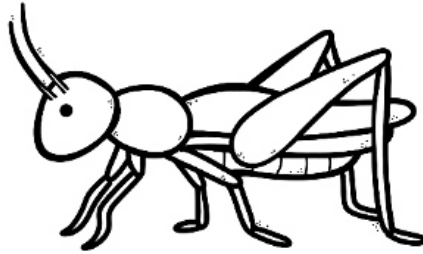

___ _ llo



ti ___ _



___ _ po



o ___ _

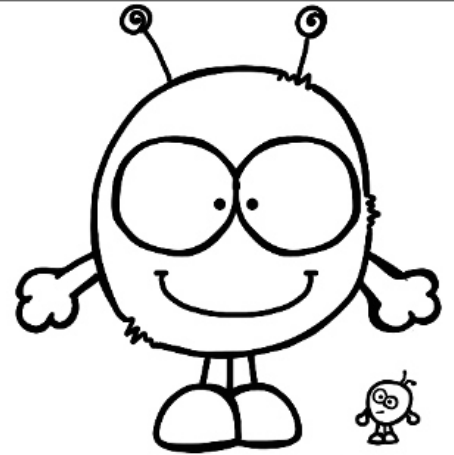

___ _ nde

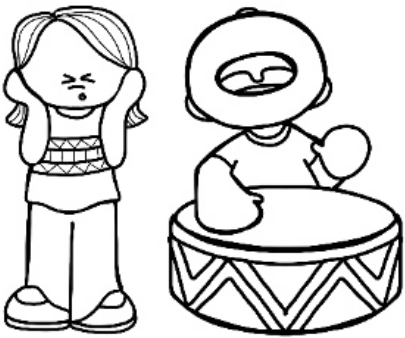

___ _ tar



ne ___ _

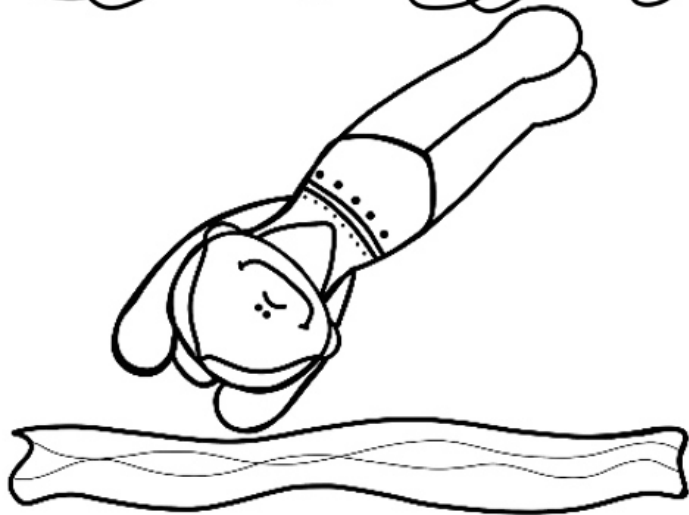
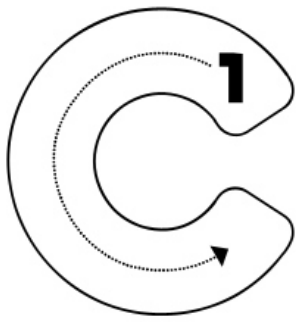

Traza siguiendo las indicaciones 

ca-ce.ci-co-cu-ca

ca-ce.ci-co-cu-ca

ca-ce.ci-co-cu-ca

ca-ce.ci-co-cu-ca

ca-ce.ci-co-cu-ca

clara-clavo-chicle-

Sílabas perdidas

CI

Escribe la sílaba que falta y colorea los dibujos.

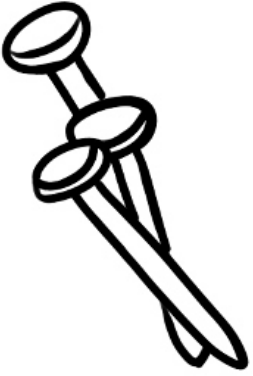

___ vos

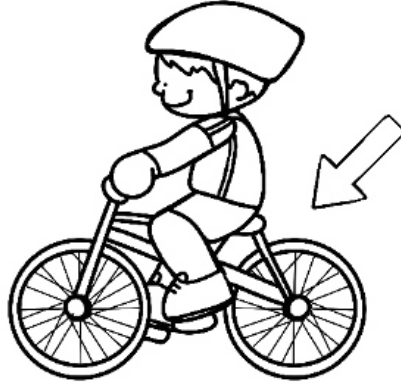

bici___ta



chi___



an___



___p

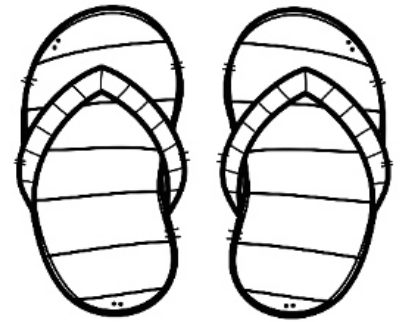

Chan___s



te___do

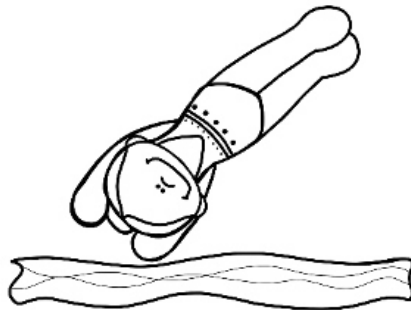

___vado



___ro

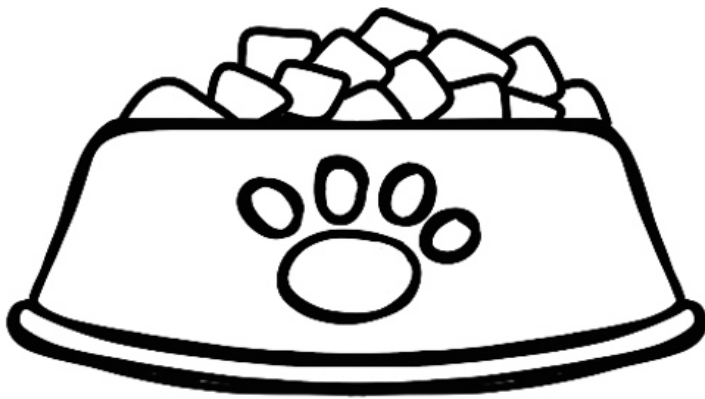
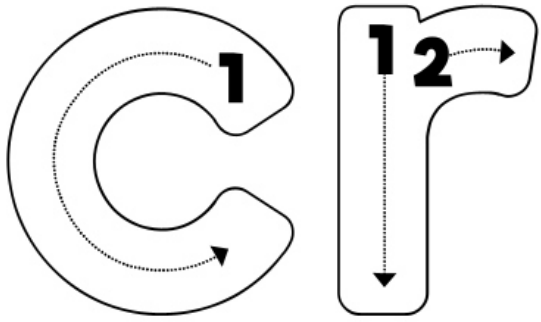

Traza siguiendo las indicaciones 

cra - cre - cri - cro - cru

cra - cre - cri - cro - cru

cra - cre - cri - cro - cru

cra - cre - cri - cro - cru

cra - cre - cri - cro - cru

crema - cristal - cráneo

Sílabas perdidas

cr

Escribe la sílaba que falta y colorea los dibujos.

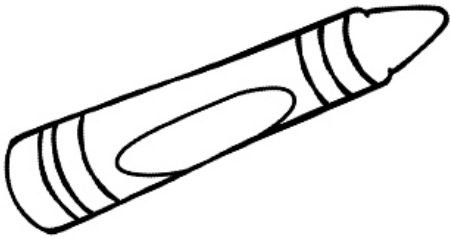

___yola



___quetas



se___taría

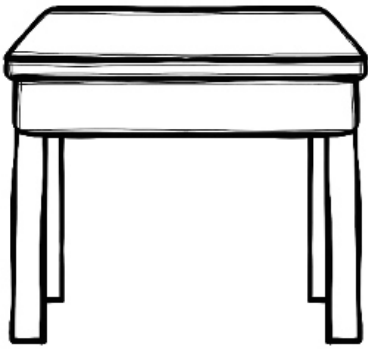

es___torio



es___bir

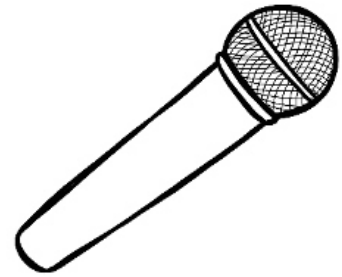

mi___fono

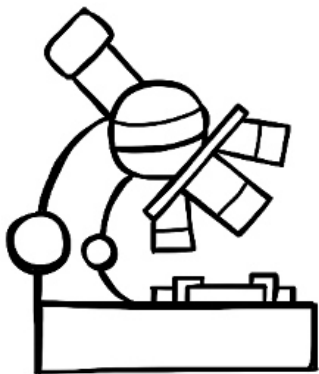

mi___scopio



___neo

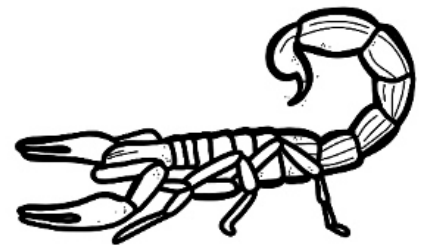

ala___n

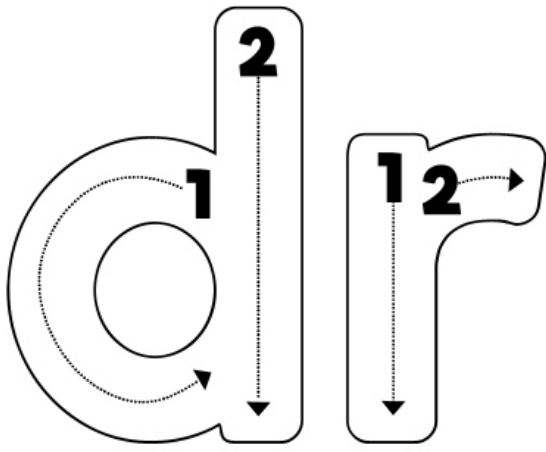

Traza siguiendo las indicaciones 

dra-dre-dri-dro-dru

dra-dre-dri-dro-dru

dra-dre-dri-dro-dru

dra-dre-dri-dro-dru

dra-dre-dri-dro-dru

drenaje-drama-padre

Sílabas perdidas

dr

Escribe la sílaba que falta y colorea los dibujos.



___ agón

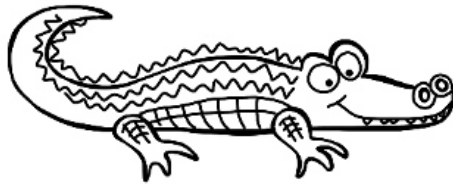

coco ___ lo

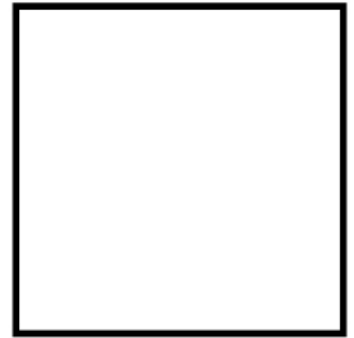

cua ___ do

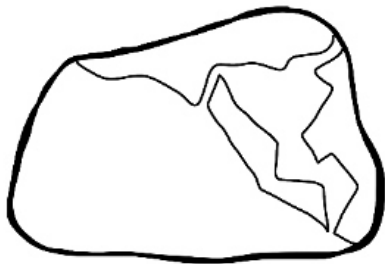

pie ___



aje ___ z

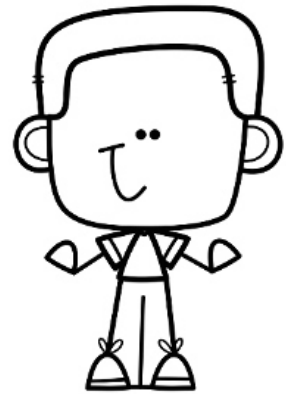

Pe ___

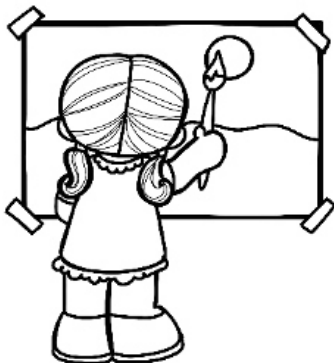

cua ___

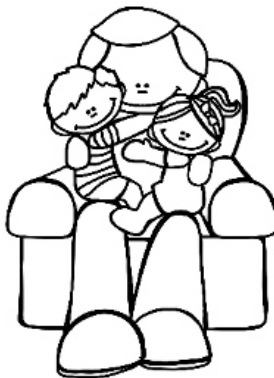

pa ___