

Jardin de Niños

Student s Name: _____

Teacher: _____

Date: _____

Decorate the crayon

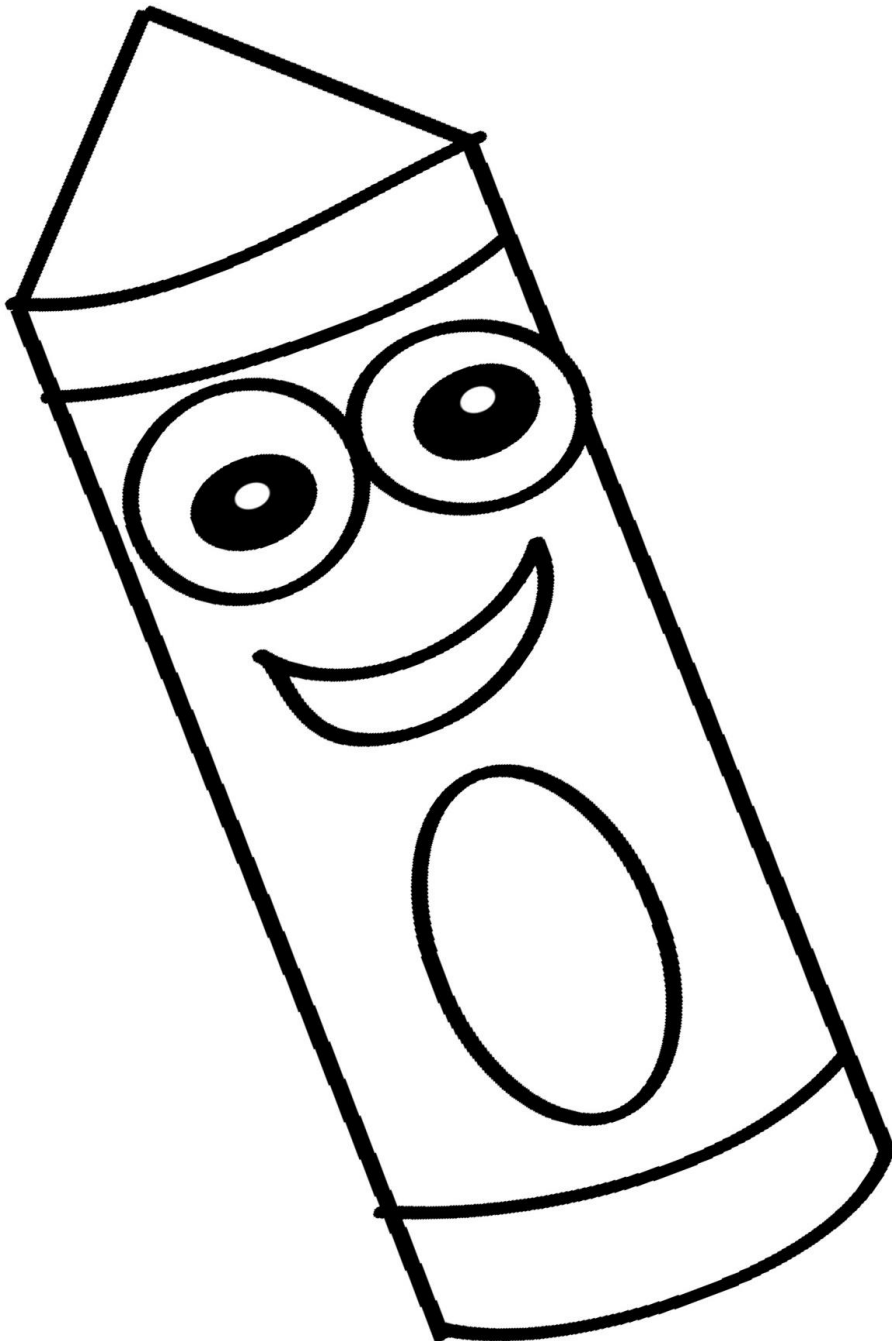

Color the chair-red, the table-blue, and circle the crayon

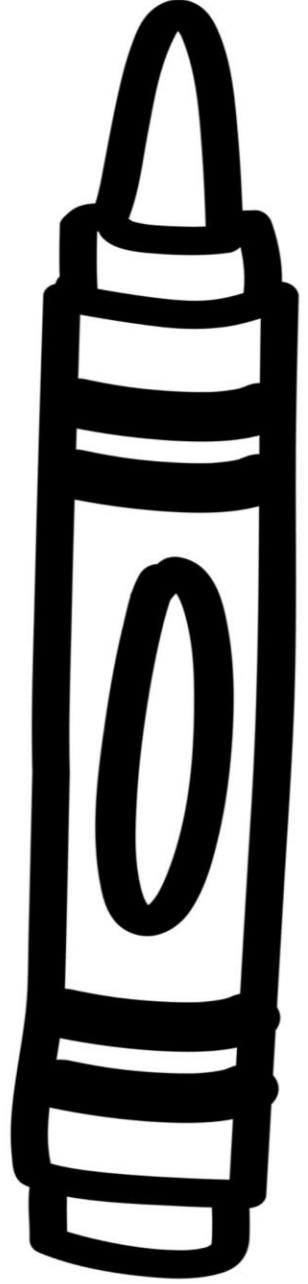
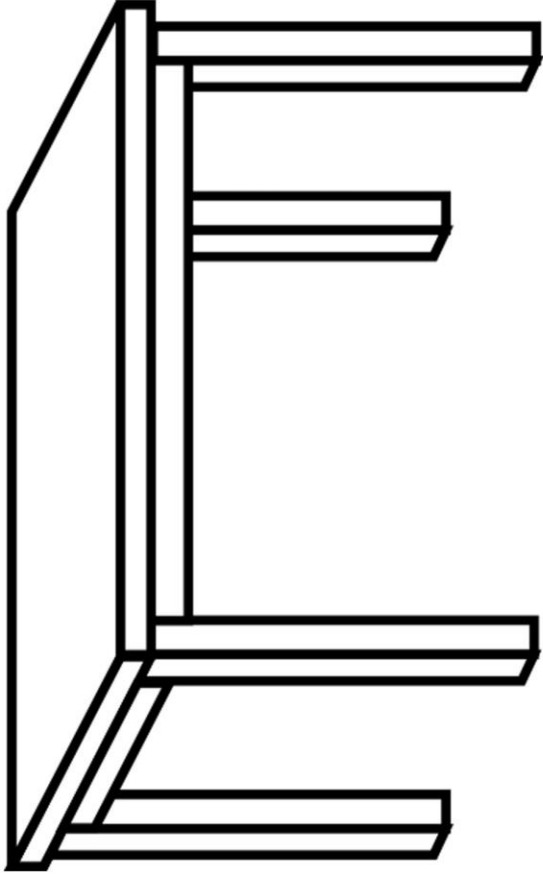
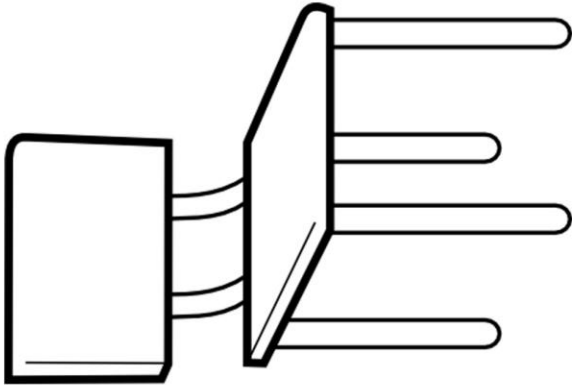

Connect the numbers to the school object, count and color

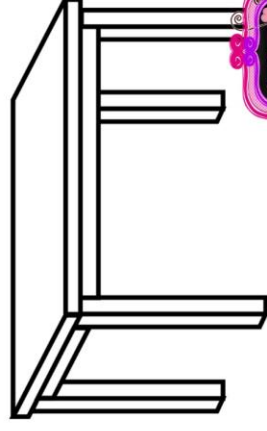
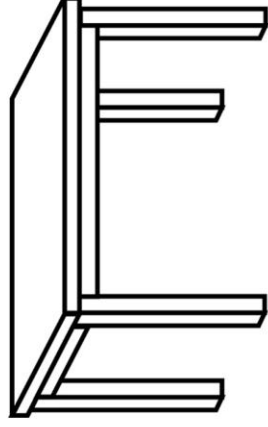
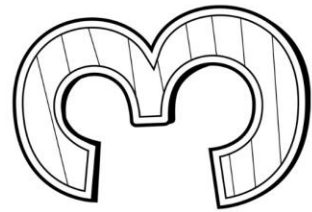
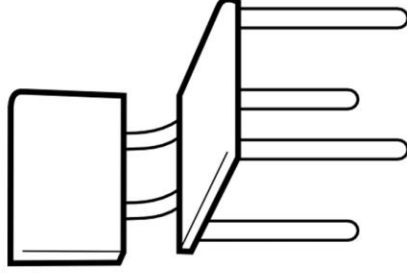
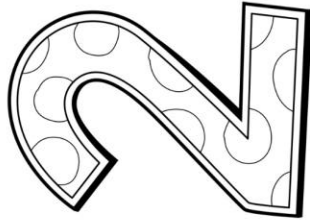
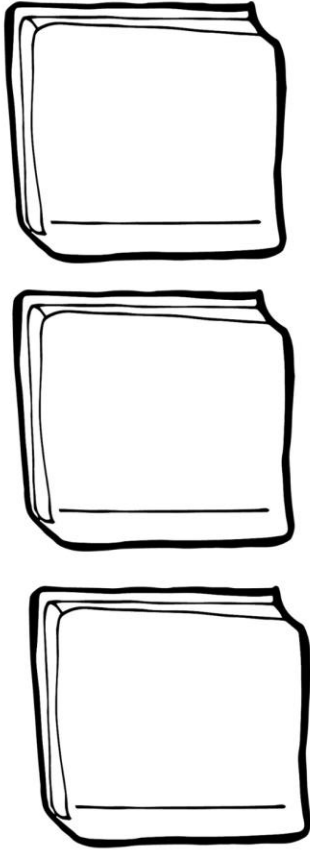
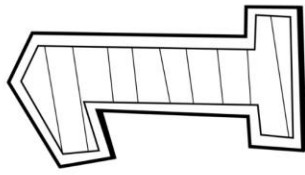

Look and circle the crayon

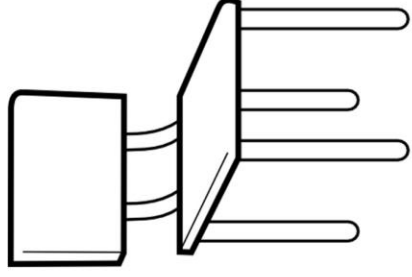
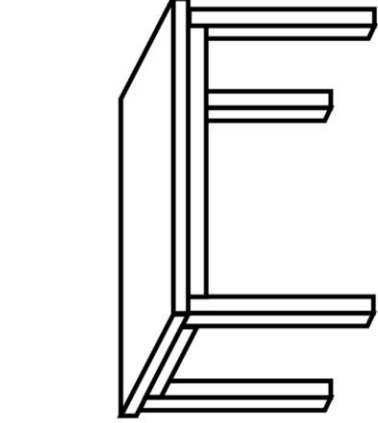
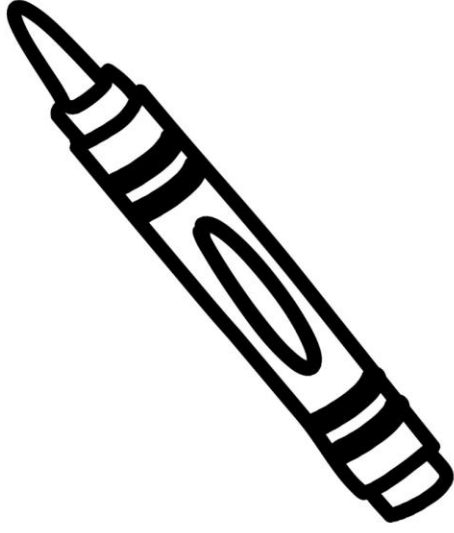
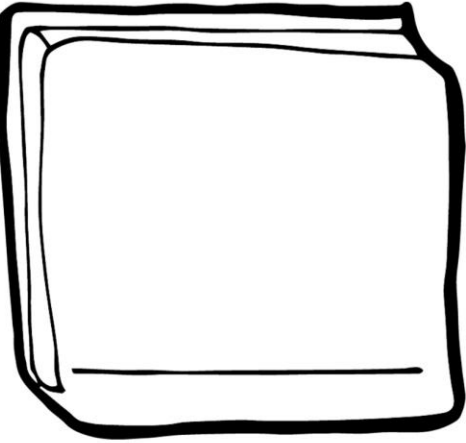
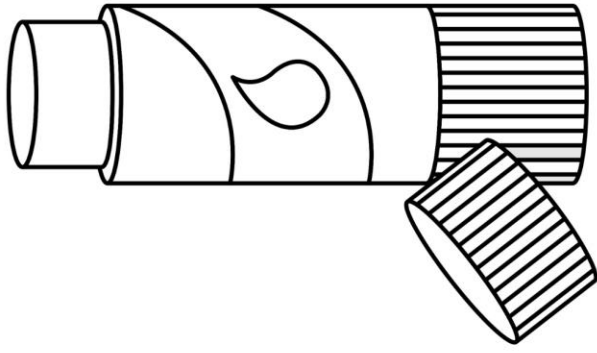

Circle the school object when you hear it's name

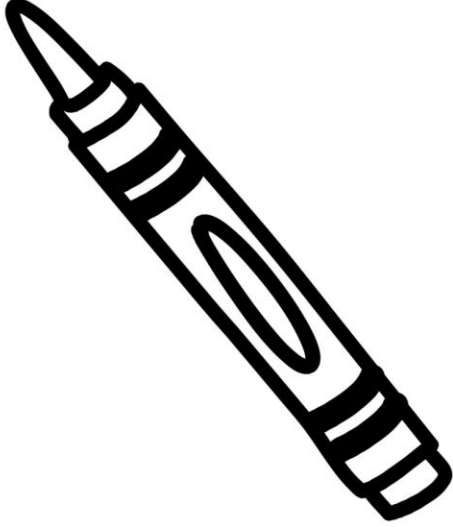
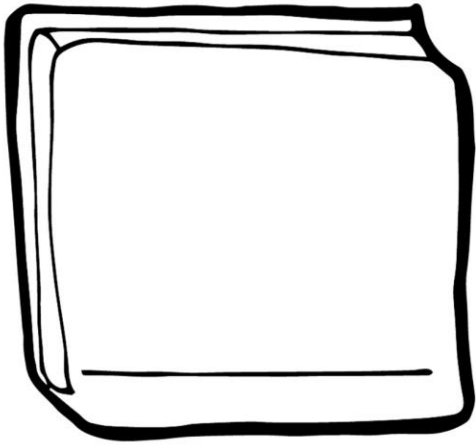

Book

Table

Crayon

Chair

